

Direct Drive, Gas Engine Flange Models

1" Hollow Shaft, SAE J609-B Flange and Set Screw
3400 RPM

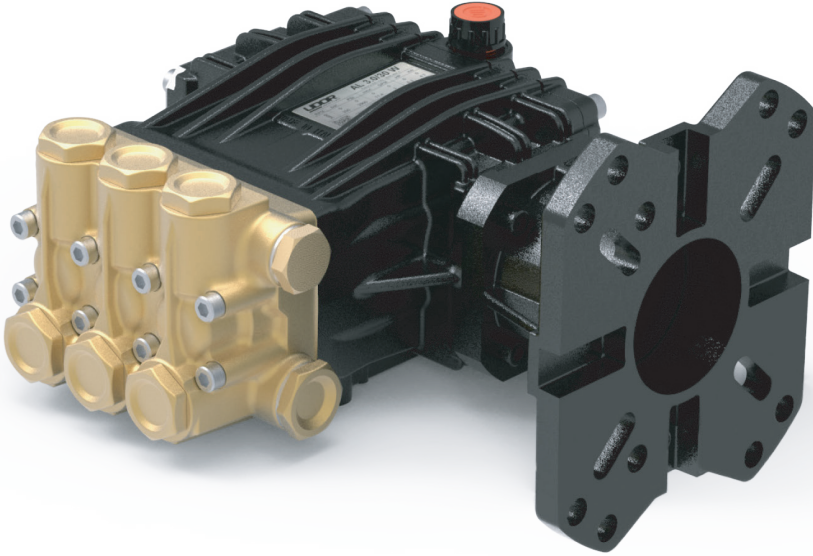

- Brass Manifold
- Heat Treated Crankshaft
- Stainless Steel Piston Guides
- High Strength Aluminum Alloy Connecting Rods
- Industrial Quality Bearings
- Solid Ceramic Plungers
- Stainless Steel Check Valves
- Heavy Duty Flat Base High Pressure Seals
- 11.5 oz. Capacity Vented Oil Bath Crank Case
- 1/2" BSP-F Inlet. 3/8" BSP-F Outlet
- Max Fluid Temp, 160°F

AL Series Direct Drive, Electric Motor Flange Plunger Pumps

A Series standard duty plunger pumps include a wide range of models with flow rates from 2.5 to 4.0 GPM and pressures up to 2900 PSI.

Other drive options include 24mm solid shaft, electric motor flange and hydraulic motor flange.

Applications include general pressure cleaning, sewer jetting, vehicle wash equipment and fire fighting applications.

	Model	Flow		Pressure		Plunger Dia.	Crankshaft		Power	Seal Kit	Valve Kit	Wt.
		GPM	l/min	PSI	bar		Stroke	Code				
3400 RPM	AL 3.0/30 W	3.0	11.4	2900	200	15mm	10.5mm	O	7.5 HP Gas	6061.07	6061.02	15.4 lbs
	AL 3.5/30 W	3.5	13.2	2900	200	15mm	9.0mm	M	9 HP Gas	6061.07	6061.02	15.4 lbs
	AL 4.0/30 W	4.0	15.0	2900	200	15mm	10.0mm	5	11 HP Gas	6061.07	6061.02	15.4 lbs

NOTE: All pump models available with left-hand drive option. Add 'L' to model number when ordering (ex. AD 4.0/30 UL)

X FLOW
MAX PRESSURE
RATED PUMP SPEED
POWER REQUIREMENT
LUBRICATION

3.5 GPM / 13.2 L/MIN
2900 PSI / 200 BAR
3400 RPM
9.0 HP GAS ENGINE
11.5 OZ UDOR LUBE

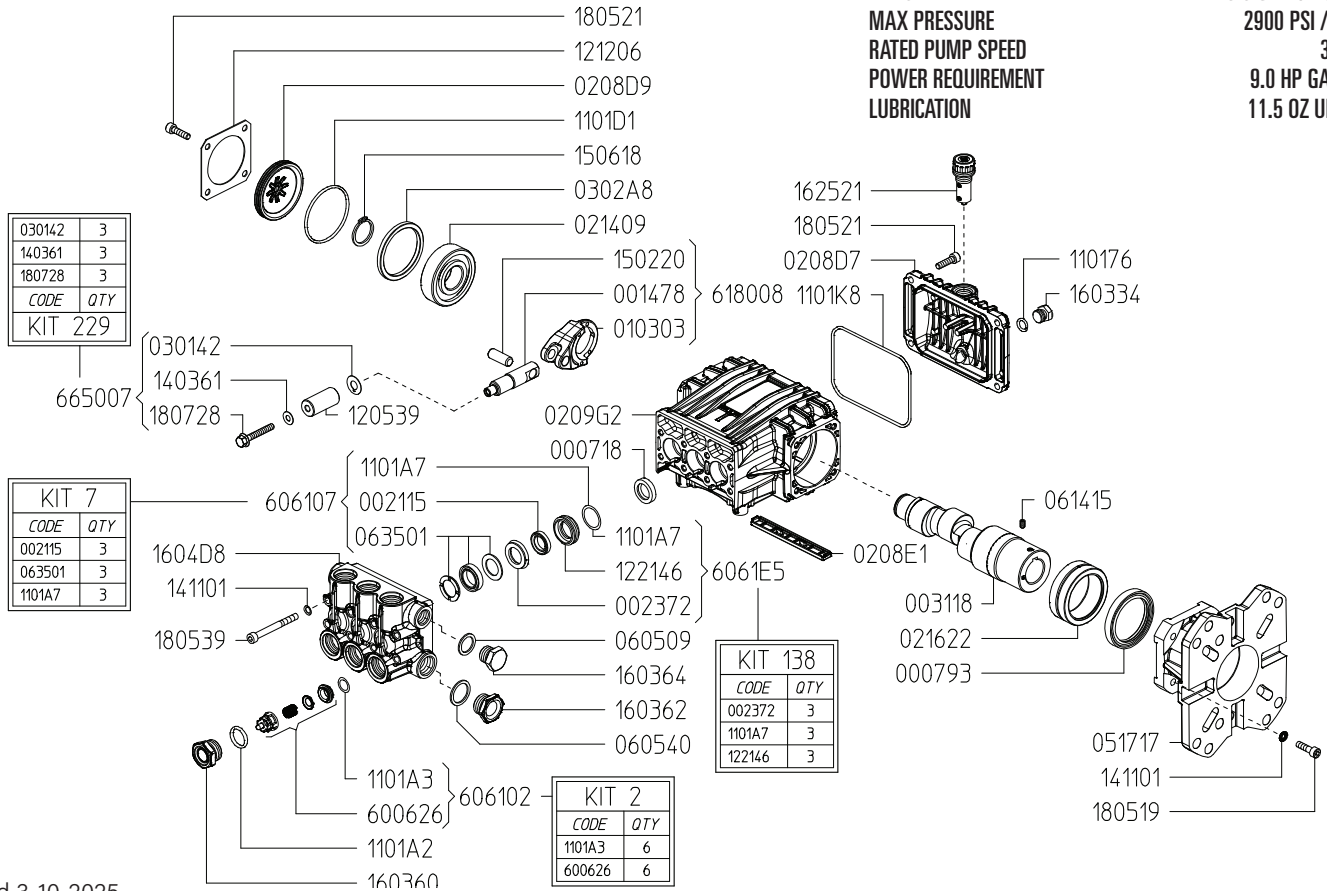

Revised 3-10-2025

Part #	Description	Qty	Part #	Description	Qty
0007.18	OIL SEAL	3	1221.46	PRESSURE RING ^C	3
0007.93	OIL SEAL	1	1403.61	WASHER ^D	3
0014.78	PLUNGER GUIDE	3	1411.01	SERRATED WASHER	8
0021.15	WATER SEAL LP ^B	3	1411.01	WASHER	4
0023.72	UPPER RING ^C	3	1502.20	PIN	3
0031.18	CRANKSHAFT - 1" HOLLOW	1	1506.18	SNAP RING	1
0103.03	CONNECTING ROD	3	1603.34	DRAIN PLUG	1
0208.D7	BACK COVER	1	1603.60	VALVE CAP	6
0208.D9	OIL SIGHT GLASS	1	1603.62	PLUG	1
0209.G2	CRANKCASE	1	1603.64	PLUG	1
0214.09	BALL BEARING	1	1604.D8	HEAD	1
0216.22	BEARING	1	1625.21	OIL PLUG - G3/8	1
0301.42	SLINGER RING ^D	3	1805.21	ALLEN BOLT	4
0302.A8	SPACER	1	1805.19	ALLEN BOLT	4
0517.17	ENGINE MOUNTING FLANGE	1	1805.21	ALLEN BOLT	4
0605.09	GASKET	1	1805.39	ALLEN BOLT	8
0605.40	GASKET	1	1807.28	PLUNGER BOLT ^D	3
0614.15	SET SCREW	1	6006.26	VALVE ASS'Y W/O O-RING ^A	6
0635.01	HIGH PRESSURE SEAL KIT ^B	3	6180.08	CONNECTING ROD ASSEMBLY	3
1101.76	O-RING	1	6061.02	VALVE KIT (KIT 2)	1
1101.A2	O-RING - VALVE CAP	6	6061.07	WATER SEAL KIT (KIT 7)	1
1101.A3	O-RING - VALVE ^A	6	6061.E5	BRASS RING KIT (KIT 138)	1
1101.A7	O-RING ^{B,C}	3	6650.07	PLUNGER BOLT KIT (KIT 229)	1
1101.D1	O-RING - OIL SIGHT GLASS	1			
1101.K8	O-RING - BACK COVER	1			
1205.39	CERAMIC PLUNGER - D15	3			
1212.06	RETAINER - SIGHT GLASS	1			

^A Parts in 6061.02 (Kit 2).
^B Parts in 6061.E2 (Kit 135).
^C Parts in 6061.E5 (Kit 138).
^D Parts in 6650.07 (Kit 229).

WEIGHT
LUBRICATION

14.3 LBS
11.5 OZ UDOR LUBE

*Dimensional Drawings are
Shown in Millimeters.
To Convert to Inches,
Multiply Dimension x 0.03937*

A SERIES PUMPS - 1" HOLLOW SHAFT w/ GAS ENGINE FLANGE

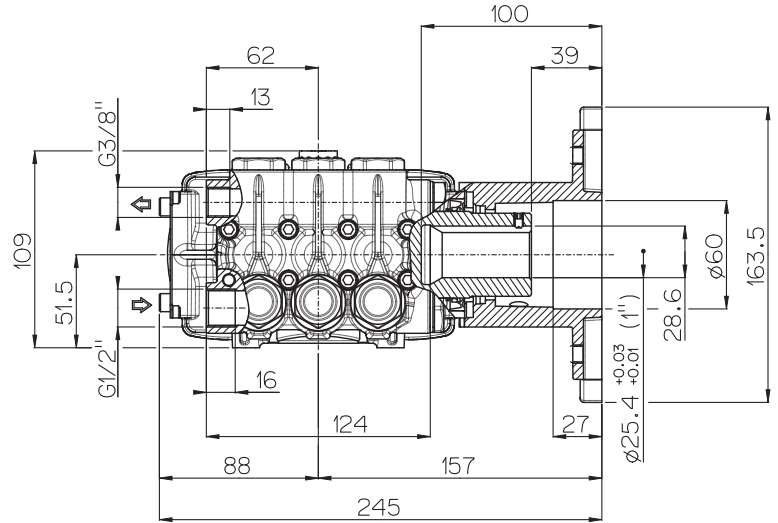
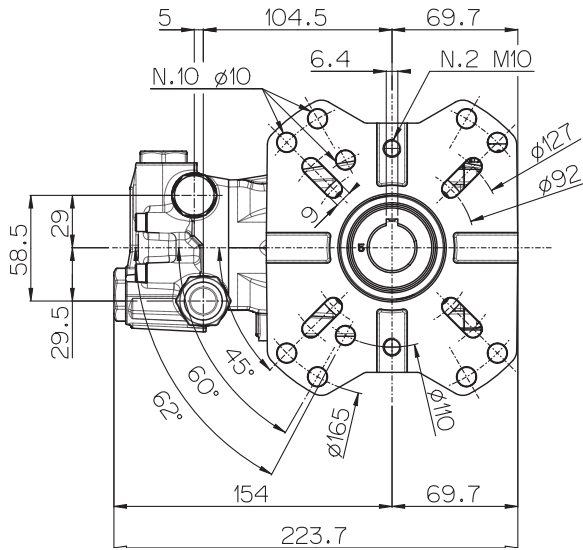

TORQUE SPECS

Ref.	Description	Ft./lb.	Nm	Loctite®
1	Head Bolts	19	25	-
2	Valve Caps	75	100	243
3	Inlet Cap	75	100	243
4	Outlet Cap	60	80	243
5	Bearing Flange Bolts	19	25	-
6	Rear Cover Bolts	19	25	-
7	Connecting Rod Bolts	9	11	243
8	Plunger Bolts	11	15	270
9	Valve Cover Bolts	-	-	-
10	Oil Drain Plug	19	25	-

